

Plot Date : 14 January 2022 10:22:12  
File Name P:\CAD\4259 THORNTON BESS\01-WORKING\01\_01-DRAWINGS\ELEVATIONS\4259-DR-P-0011.P1

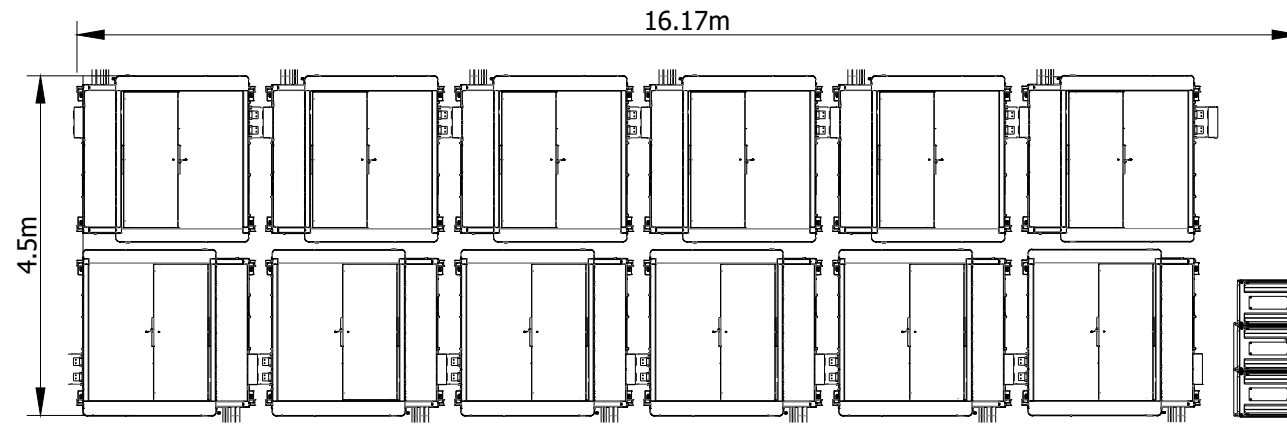

PLAN

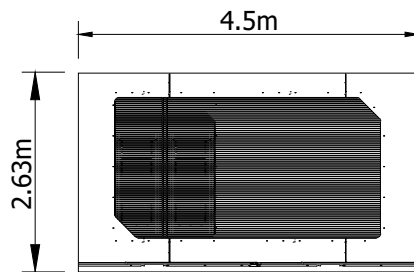

END ELEVATION

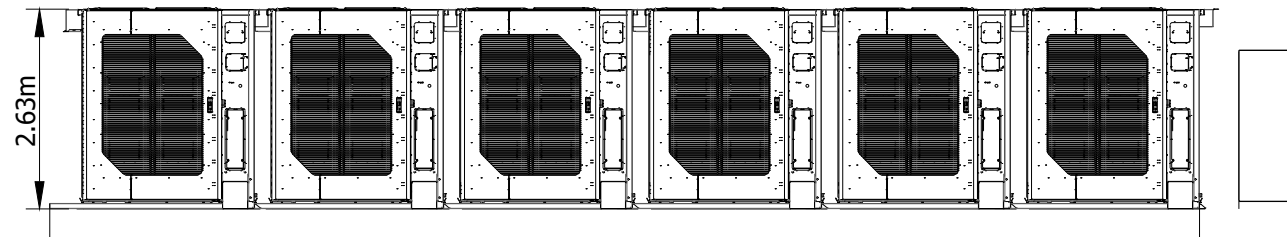

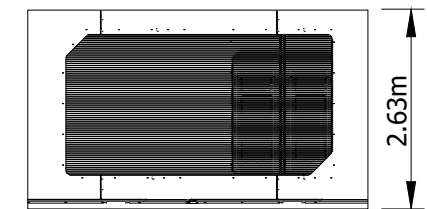

ELEVATION

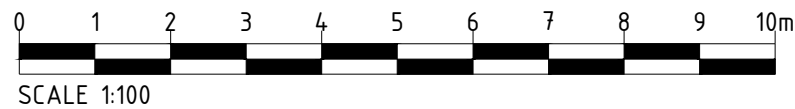

END ELEVATION



Project Title <b>SOAY SOLAR FARM AND GREENER GRID PARK</b>		Drawing Title <b>FIGURE 11 INDICATIVE BATTERY ELEVATIONS (GREENER GRID PARK)</b>		Purpose of issue <b>PLANNING</b>		THIS DOCUMENT HAS BEEN PREPARED IN ACCORDANCE WITH THE SCOPE OF ARCUS' APPOINTMENT WITH ITS CLIENT AND IS SUBJECT TO THE TERMS OF THAT APPOINTMENT. ARCUS ACCEPTS NO LIABILITY FOR ANY USE OF THIS DOCUMENT OTHER THAN BY ITS CLIENT AND ONLY FOR THE PURPOSES FOR WHICH IT WAS PREPARED AND PROVIDED		Arcus Consultancy Services 7th Floor 144 West George Street Glasgow, G2 2HG Tel: +44 (0)141 221 9997 Fax: +44 (0)141 221 5610 <a href="http://www.arcusconsulting.co.uk">www.arcusconsulting.co.uk</a>			
Client 		Designed - Drawn SR Arcus Internal Project No. 4259 Scale @ A3 1:100		Checked DB Approved DB Date 14/01/22							